

General Description:

Using advanced IGBT technology, the 600V IGBT. Offers superior conduction and switching performances.

Lead Free Package and Finish

V_{CES}	$V_{CE(sat)}$	I_C
600V	2.0V	15A

Features:

● Low saturation voltage: $V_{CE(sat),typ}=2.0V @I_C=15A$, and $T_C = 25^{\circ}C$;

● RoHS Compliant;

Applications:

- Inverter welder
- Solar inverters
- UPS
- High switching frequency inverter

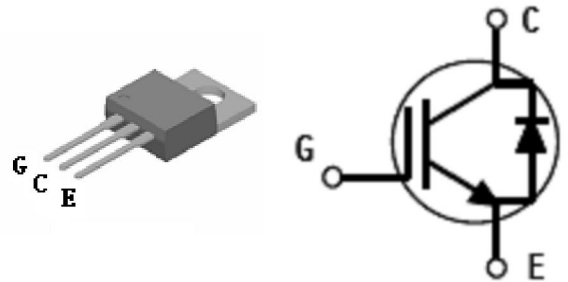

Ordering Information

Part Number	Package	Brand
IGP15N60F	TO-220	IPS

Absolute Maximum Ratings (Ta= 25°C, unless otherwise specified)

Symbol	Parameter	Rating	Units
V_{CES}	Collector-Emitter Voltage	600	V
V_{GES}	Gate- Emitter Voltage	± 20	V
I_C	Collector Current	30	A
	Collector Current @ $T_C=100^{\circ}C$	15	
I_{CM}^{a1}	Pulsed Collector Current @ $T_C=25^{\circ}C$	45	A
I_F	Diode Continuous Forward Current@ $T_C=100^{\circ}C$	10	A
I_{FM}	Diode Maximum Forward Current	30	A
P_D	Power Dissipation @ $T_C=25^{\circ}C$	100	W
	Power Dissipation @ $T_C=100^{\circ}C$	40	
	Power Dissipation @ $T_A=25^{\circ}C$	2.0	
T_J	Operating Junction	150	$^{\circ}C$
T_{stg}	Storage Temperature Range	-55~150	$^{\circ}C$
T_L	Maximum Temperature for Soldering	270	$^{\circ}C$

a1: Repetitive rating; pulse width limited by maximum junction temperature



IGP15N60F

Thermal Characteristics

Symbol	Parameter	Typ.	Max.	Units
$R_{\theta JC}$	Thermal Resistance, Junction to case for IGBT	--	1.25	$^{\circ}C/W$
$R_{\theta JC}$	Thermal Resistance, Junction to case for Diode	--	2.50	$^{\circ}C/W$
$R_{\theta JA}$	Thermal Resistance, Junction to Ambient	--	62.5	$^{\circ}C/W$

Electrical Characteristics of the IGBT ($T_a = 25^{\circ}C$, unless otherwise specified)

Symbol	Parameter	Test Conditions	Rating			Units
			Min	Typ.	Max.	
OFF Characteristics						
$V_{(BR)CES}$	Collector-Emitter Breakdown Voltage	$V_{GE}=0V, I_{CE}=250\mu A$	600	--	--	V
I_{CES}	Collector-Emitter Leakage Current	$V_{GE}=0V, V_{CE}=600V$	--	--	1.0	mA
$I_{GES(F)}$	Gate to Emitter Forward Leakage	$V_{GE}=+20V$	--	--	+250	nA
$I_{GES(R)}$	Gate to Source Reverse Leakage	$V_{GE}=-20V$	--	--	-250	nA
ON Characteristics						
$V_{CE(sat)}$	Collector-Emitter Saturation Voltage	$I_C=15A, V_{GE}=15V$	--	2.0	2.6	V
$V_{GE(th)}$	Gate Threshold Voltage	$I_C=1mA, V_{CE}=V_{GE}$	5.0	6.0	7.0	V
Pulse width $t_p \leq 380\mu s, \delta \leq 2\%$						
Dynamic Characteristics						
C_{ies}	Input Capacitance	$V_{CE}=30V, V_{GE}=0V$ $f=1MHz$	--	675	--	pF
C_{oes}	Output Capacitance		--	80	--	
C_{res}	Reverse Transfer Capacitance		--	18.5	--	
Switching Characteristics						
$t_{d(on)}$	Turn-on Delay Time	$V_{CE}=400V, I_C=15A,$ $R_g=10\Omega, V_{GE}=15V,$ Inductive Load, $T_a=25^{\circ}C,$	--	25.8	--	ns
t_r	Rise Time		--	19.0	--	
$t_{d(off)}$	Turn-Off Delay Time		--	57.6	--	
t_f	Fall Time		--	32	--	
E_{on}	Turn-On Switching Loss		--	0.761	--	mJ
E_{off}	Turn-Off Switching Loss		--	0.081	--	
E_{ts}	Total Switching Loss		--	0.842	--	
Q_g	Total Gate Charge	$V_{CE}=400V, I_C=15A$ $V_{GE}=15V,$	--	33	--	nC
Q_{ge}	Gate to Emitter Charge		--	7.8	--	
Q_{gc}	Gate to Collector Charge		--	16	--	
Electrical Characteristics of the Diode						
V_F	Diode Forward Voltage	$I_F=10A$	--	1.3	2.1	V
T_{rr}	Reverse Recovery Time	$I_F=10A$ $di/dt=100A/\mu s$	--	88	--	ns
I_{rr}	Diode Peak Reverse Recovery Current		--	3.0	--	A
Q_{rr}	Reverse Recovery Charge		--	132	--	nC

Characteristics Curve:

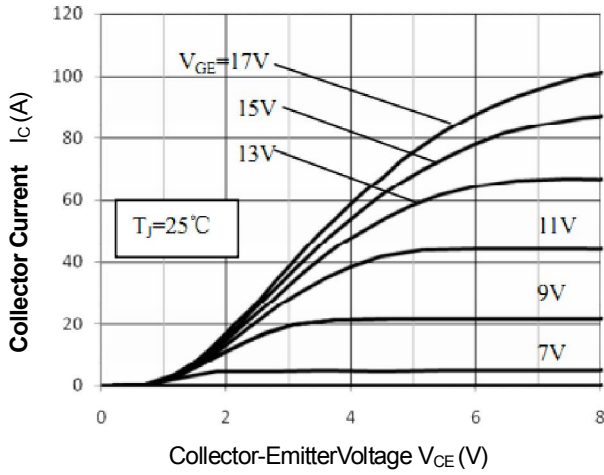

Figure 1. Typical Output Characteristics

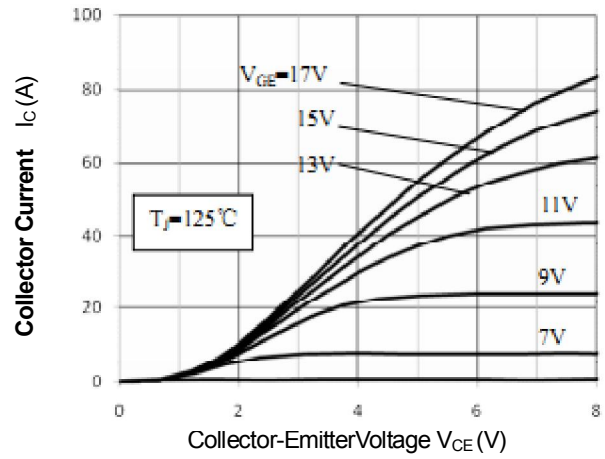

Figure 2. Typical Output Characteristics

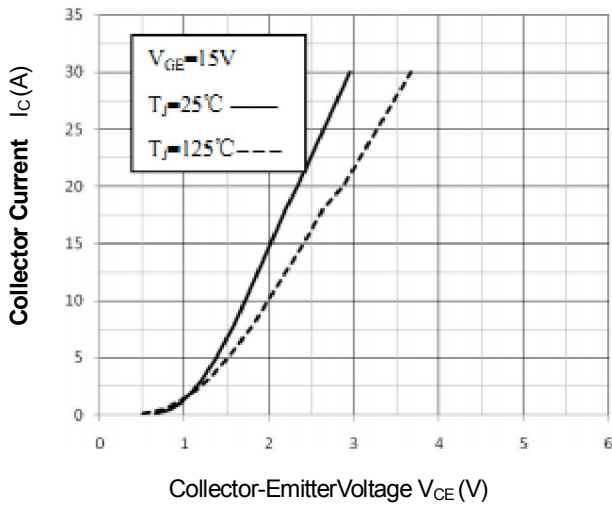

Figure 3. Saturation Voltage Characteristics

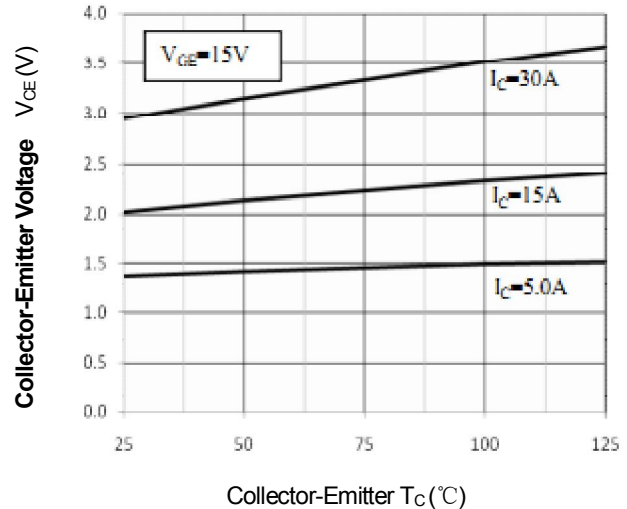

Figure 4. Saturation Voltage - T_c Characteristics

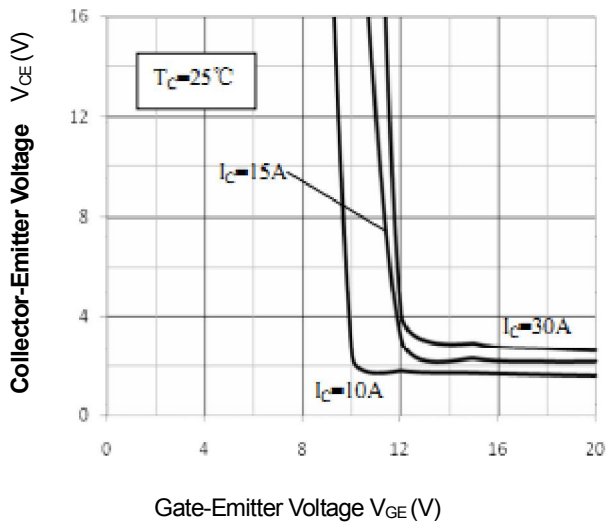

Figure 5. $V_{CE(sat)}$ - V_{GE} Characteristics

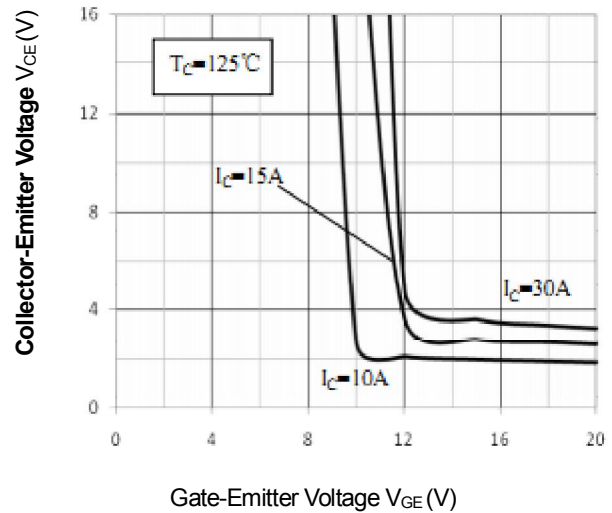

Figure 6. $V_{CE(sat)}$ - V_{GE} Characteristics

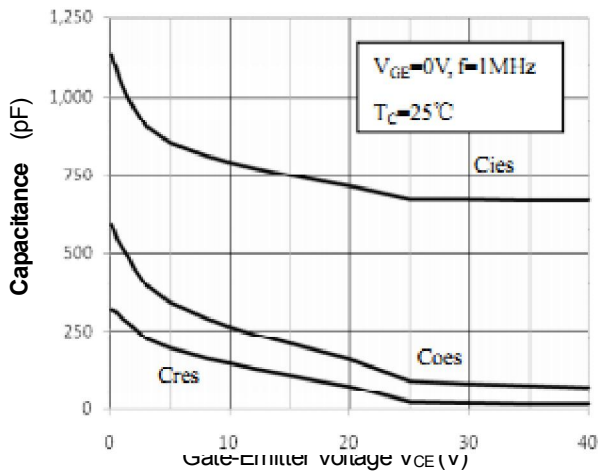

Figure 7. Capacitance Characteristics

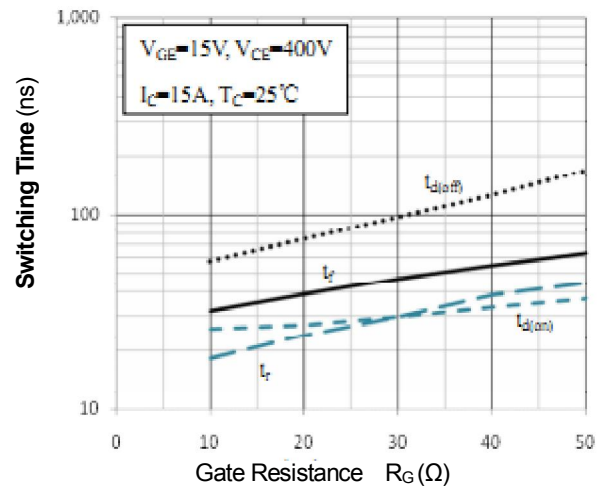

Figure 8. Switching Time— R_G Characteristics

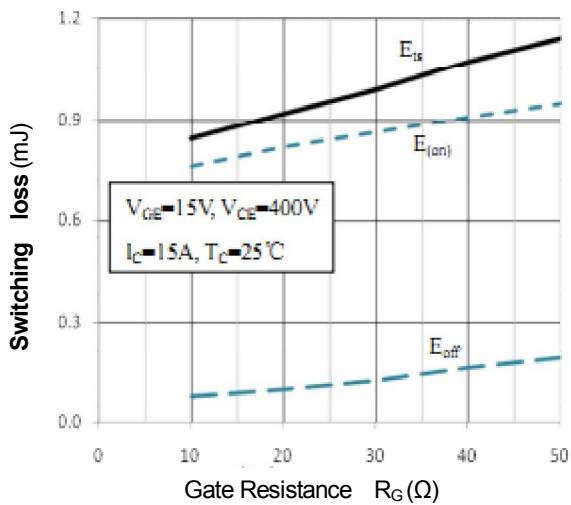

Figure 9. Switching loss— R_G Characteristics

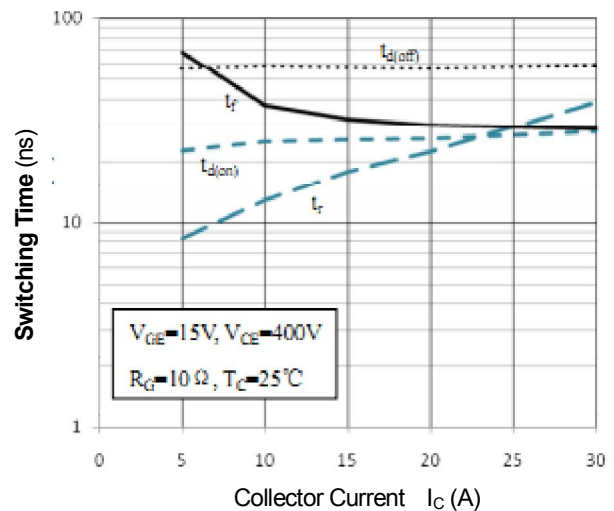

Figure 10. Switching Time— I_C Characteristics

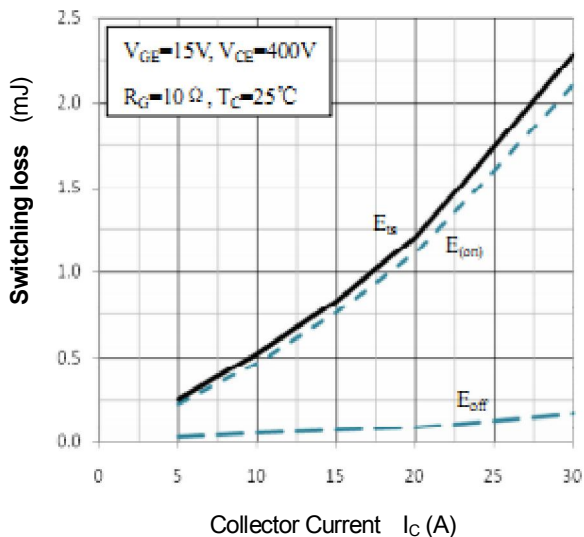

Figure 11. Switching loss— I_C Characteristics

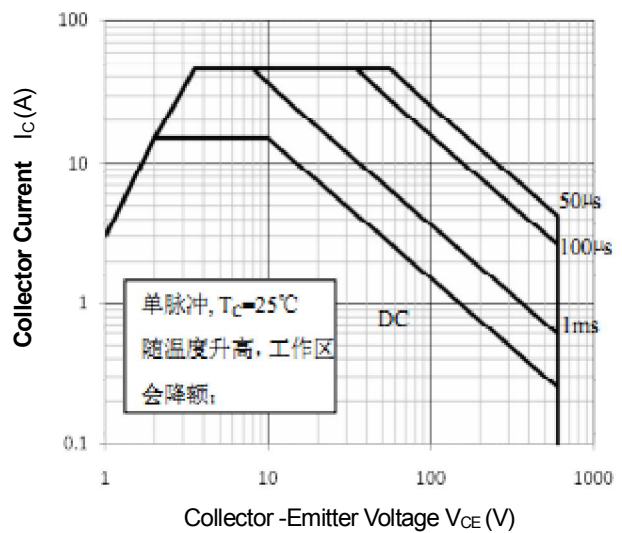

Figure 12. Safe Operating Area

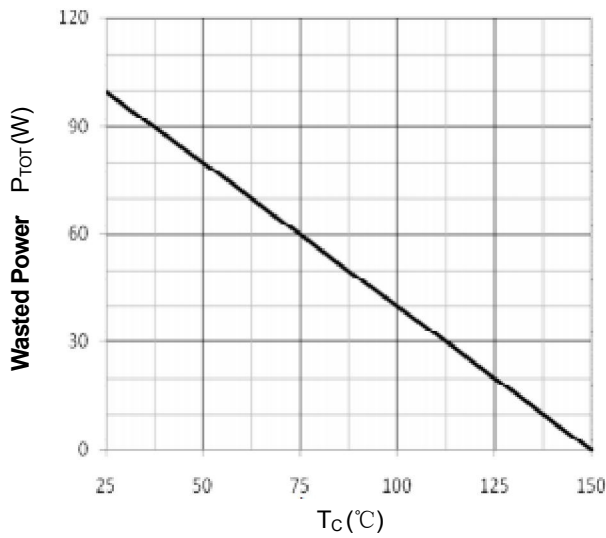

Figure 13. Power Dissipation— T_c Characteristics

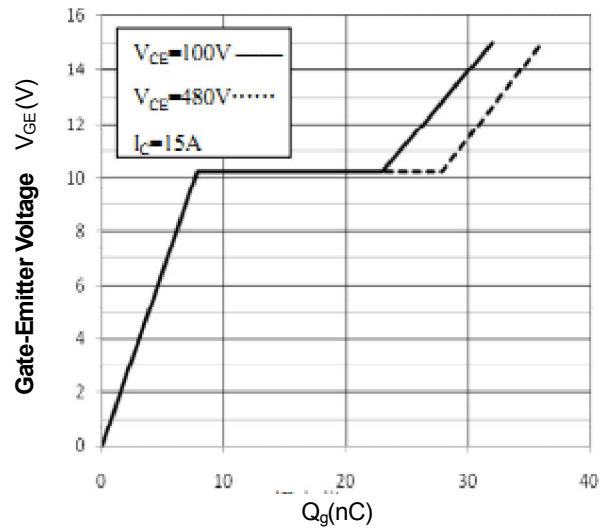

Figure 14. Gage Charge Characteristics

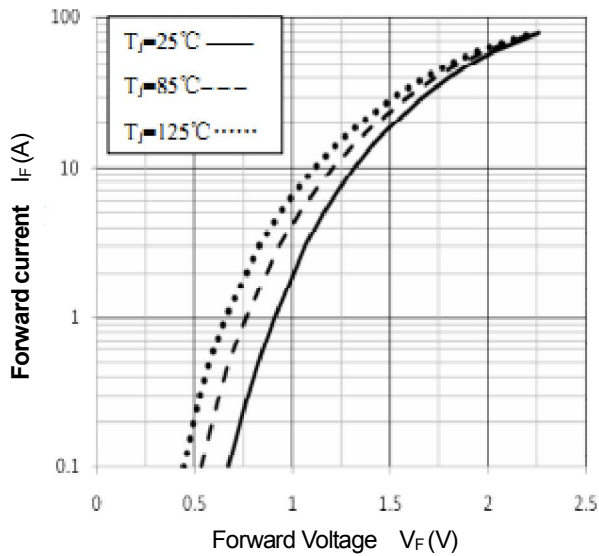

Figure 15. Diode Forward Characteristics

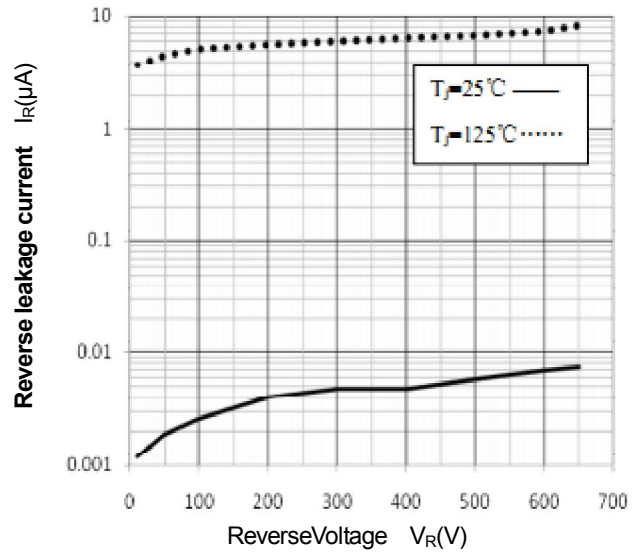

Figure 16. Diode Reverse Characteristics

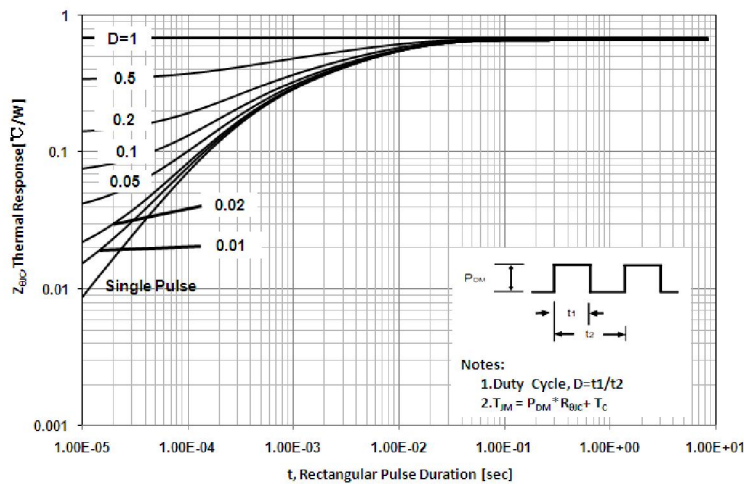

Figure 17. IGBT Transient Thermal Impedance



Disclaimers:

InPower Semiconductor Co., Ltd (IPS) reserves the right to make changes without notice in order to improve reliability, function or design and to discontinue any product or service without notice. Customers should obtain the latest relevant information before orders and should verify that such information is current and complete. All products are sold subject to IPS's terms and conditions supplied at the time of order acknowledgement.

InPower Semiconductor Co., Ltd warrants performance of its hardware products to the specifications at the time of sale, Testing reliability and quality control are used to the extent IPS deems necessary to support this warrantee. Except where agreed upon by contractual agreement, testing of all parameters of each product is not necessarily performed.

InPower Semiconductor Co., Ltd does not assume any liability arising from the use of any product or circuit designs described herein. Customers are responsible for their products and applications using IPS's components. To minimize risk, customers must provide adequate design and operating safeguards.

InPower Semiconductor Co., Ltd does not warrant or convey any license either expressed or implied under its patent rights, nor the rights of others. Reproduction of information in IPS's data sheets or data books is permissible only if reproduction is without modification or alteration. Reproduction of this information with any alteration is an unfair and deceptive business practice. InPower Semiconductor Co., Ltd is not responsible or liable for such altered documentation.

Resale of IPS's products with statements different from or beyond the parameters stated by InPower Semiconductor Co., Ltd for that product or service voids all express or implied warranties for the associated IPS's product or service and is unfair and deceptive business practice. InPower Semiconductor Co., Ltd is not responsible or liable for any such statements.

Life Support Policy:

InPower Semiconductor Co., Ltd's products are not authorized for use as critical components in life support devices or systems without the expressed written approval of InPower Semiconductor Co., Ltd.

As used herein:

1. Life support devices or systems are devices or systems which:
 - a. are intended for surgical implant into the human body,
 - b. support or sustain life,
 - c. whose failure to perform when properly used in accordance with instructions for use provided in the labeling, can be reasonably expected to result in significant injury to the user.

2. A critical component is any component of a life support device or system whose failure to perform can be reasonably expected to cause the failure of the life support device or system, or to affect its safety or effectiveness.